



DATOS MOTOR

POTENCIA	0.75HP
REVOLUCIONES	1760
FRECUENCIA	60HZ
TORQUE MOTOR NOMINAL	3,1
CARCASA (PAM)	80(B5)
TIPO BRIDA	FF-165
EFICIENCIA MOTOR	IE 2

DATOS REDUCTOR

REFERENCIA	541107
TIPO	ORTOGONAL
MODELO	FCN
MATERIAL	ALUMINIO
CARCASA	50
RELACION DE TRANSMISION i:	20
VELOCIDAD SALIDA	88,00
TORQUE MAXIMO	73
TORQUE OPERACIÓN	49
FACTOR DE SERVICIO	1,5

PLANOS REDUCTOR

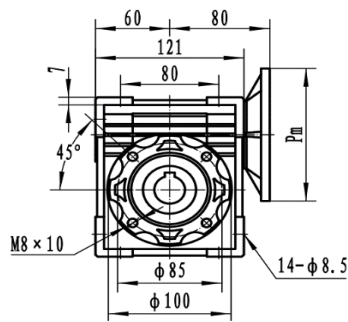

FCN 50

Input shaft hole

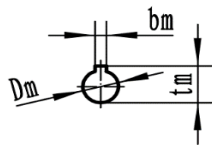

Output shaft hole

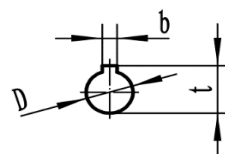

Dimensions of output shaft				
D	H7	b	D10	t
25		8		28.3

	Pm	Dm	bm	tm
63B5	140	11	4	12.8
63B14	90			
71B5	160	14	5	16.3
71B14	105			
80B5	200	19	6	21.8
80B14	120			

